

Owner's Manual

9.33

Low-Impact Treadmill



PRECOR^{USA}
move beyond[®]

Important Safety Instructions

When using an electrical appliance, always take basic precautions, including the following:

- Read all instructions before using the treadmill. These instructions are written to ensure your safety and to protect the unit.
- Before beginning any fitness program, see your physician for a complete physical examination.

Il est conseillé de subir un examen médical complet avant d'entreprendre tout programme d'exercise. Si vous avez des étourdissements ou des faiblesses, arrêtez les exercices immédiatement.

DANGER To reduce the risk of electrical shock always unplug the treadmill from the electrical outlet immediately after using and before cleaning.

WARNING To reduce the risk of burns, fire, electric shock, or injury, take the following precautions:

- Do not allow children or those unfamiliar with its operation on or near the treadmill. Do not leave children unsupervised around the unit.

- Never leave the treadmill unattended when it is plugged in. Unplug the treadmill from the power source when it is not in use, before cleaning it, and before putting on or taking off parts.
- Assemble and operate the treadmill on a solid, level surface. Locate the treadmill a few feet from walls or furniture. Keep the area behind the treadmill clear.
- Maintain the treadmill in good working condition. Refer to the *Maintenance* section. Make sure that all fasteners are secure and the belt is clean and running smoothly.
- Use the treadmill only for its intended purpose as described in this manual. Do not use accessory attachments that are not recommended by the manufacturer, as such attachments may cause injuries.
- Never operate the unit if it is damaged, not working properly, when it has been dropped, or has been dropped in water. Return the treadmill to a service center for examination and repair.
- Keep the power cord and plug away from heated surfaces.
- Do not operate the treadmill where aerosol (spray) products are being used or where oxygen is being administered.

- Do not use outdoors.
- Never block the air vents while operating the treadmill. Keep the air vents clean and free of lint, hair, or anything that might impede the free flow of air.
- Do not attempt to service the treadmill yourself except to follow the maintenance instructions found in this manual.
- Never drop or insert objects into any opening. Keep hands away from moving parts.
- Keep all electrical components, such as the power cord and I/O switch, away from liquids to prevent shock. Do not set anything on the handrails, display console, or hood. Place liquids, magazines, and books in the appropriate receptacles.

DANGER

The treadmill must be connected to a dedicated, grounded circuit. See *Grounding Instructions*.

- Wear proper exercise clothing and shoes for your workout and avoid loose clothing. Do not wear shoes with heels or leather soles. Check the soles of your shoes and remove any dirt and embedded stones. Tie long hair back.

- Use care when getting on or off the treadmill. Always grasp the handrail when stepping on the running belt and keep the initial speed at or below 1 mile per hour (mph) or 1 kilometer per hour (kph). Never step off the treadmill while the running belt is moving.
- Before the running belt begins moving (before your workout), and after it stops (at the end of your workout), straddle the belt by placing your feet firmly on the right and left staging platforms.
- Keep your body and head facing forward. Never attempt to turn around on the treadmill.
- The security clip must be attached at waist level before your workout. A lanyard connects the security clip to the red STOP button on the display console. If you encounter difficulties, a strong tug on the lanyard stops the running belt.
- Do not rock the unit. Do not stand on the handrail(s), display console, or hood.
- Do not overexert yourself or work to exhaustion. If you feel any pain or abnormal symptoms, stop your workout immediately and consult your physician.
- When the treadmill is not in use, disconnect the unit by turning the power switch to the OFF (O) position, and then remove the power plug from the wall outlet.

Password Security

To help prevent unauthorized use, the treadmill is equipped with password protection. The password involves entering three keys in sequence. If the correct keys are not pressed within two minutes, further access is denied and the running belt will not move. For more information, refer to *Entering the Password*.

Safety Approval

When identified with the ETL-c logo, the unit has been tested and conforms to the requirements of CAN/CSA-E-335-1/3-94, *Safety of Household and Similar Electrical Appliances*.

Grounding Instructions

The treadmill must be grounded. If the unit malfunctions or breaks down, grounding provides a path of least resistance for electric current, which reduces the risk of electrical shock. The unit is equipped with a power cord having an equipment-grounding conductor and a grounding plug. The plug must be inserted into an outlet that is properly installed and grounded in accordance with all local codes and ordinances. Failure to properly ground the treadmill could void the Precor Limited Warranty.

DANGER

Improper connection of the equipment-grounding conductor can result in a risk of electric shock. Check with a qualified electrician or service person if you are in doubt as to whether the unit is properly grounded. Do not modify the plug provided with the treadmill. If it does not fit the outlet, get a proper outlet installed by a qualified electrician.

120 V Units Designated for U.S. Markets

The treadmill must be connected to a dedicated, grounded circuit with a nominal 120-volt rating. The unit's grounding plug looks like the plug shown in Diagram 1. The power outlet must have the same configuration as the plug. No adapter should be used with this product.

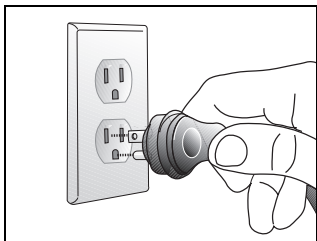

Diagram 1: Power plug

Radio Frequency Interference (RFI)

Federal Communications Commission, Part 15

The treadmill has been tested and found to comply with

- the IEC EMC Directive (international electromagnetic compatibility certification)
- the limits for a Class B digital device, pursuant to Part 15 of the FCC Rules. These limits are designed to provide reasonable protection against harmful interference in a residential installation. The treadmill generates, uses, and can radiate radio frequency energy and, if not installed and used in accordance with the owner's manual instructions, may cause harmful interference to radio communications.

If the treadmill does cause harmful interference to radio or television reception, which can be determined by turning the unit OFF and ON, you are encouraged to try to correct the interference using one or more of the following measures:

- Reorient or relocate the receiving antenna for your TV, radio, VCR, etc.
- Increase separation between the unit and the receiver (TV, radio, etc.).

- Connect the treadmill into a different power outlet on a dedicated circuit different from the one used by the receiver (TV, radio, etc.). No other appliance should be plugged into the same power outlet as the treadmill
- Consult an experienced radio/TV technician for help.

WARNING Per FCC rules, changes or modifications not expressly approved by Precor could void the user's authority to operate the equipment.

Canadian Department of Communications

This digital apparatus does not exceed the Class B limits for radio noise emissions from digital apparatus set out in the Radio Interference Regulations of the Canadian Department of Communications.

Le présent appareil numérique n'émet pas de bruits radioélectriques dépassant les limites applicables aux appareils numériques de la class B prescrites dans le Règlement sur le brouillage radioélectrique édicté par le ministère des Communications du Canada.

ATTENTION: Haute Tension

Débranchez avant de réparer

Owner's Manual: Important Safety Instructions

European Applications

This product conforms to the requirements of the European Council Directive 89/336/EEC, *Electromagnetic Compatibility* and has been tested to the following standards:

- **EN55022**, Limits & Methods of Measurement of Radio Interference, Information Technology Equipment.
- **EN50082-1**, Generic Immunity Standard for Residential, Commercial and Light Industrial Products.

This product additionally conforms to the requirements of the European Council Directive 73/23/EEC, Low Voltage Directive and has been tested to the following standard:

- **IEC 335-1**, Safety of Household and Similar Electrical Appliances.

Obtaining Service

Do not attempt to service the treadmill yourself, except for the maintenance procedures described in this manual. The treadmill does not contain any user-serviceable parts. For information about product operation or service, see the Precor web site at www.precor.com or call Precor Customer Support at 1-800-347-4404.

You will need the model and serial numbers whenever you contact Precor Customer Support. The serial number is printed on a label located on the front panel, near the power cord (Diagram 2). For future reference, write the model and serial number and date of purchase in the space provided.

Model #: _____ Serial #: _____

Date purchased: _____

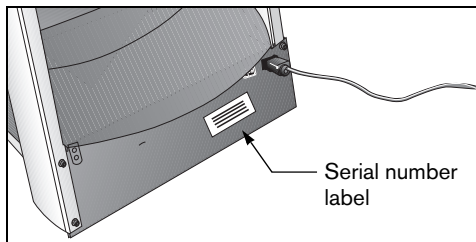

Diagram 2: Location of serial number

Owner's Manual: Important Safety Instructions

Table of Contents

Important Safety Instructions	1
Password Security	3
Safety Approval	3
Grounding Instructions	3
Radio Frequency Interference (RFI)	4
European Applications	5
Obtaining Service	6
Treadmill Safety Features	9
Using the Security Clip	9
Entering the Password	9
Using the Handrails	10
Turning the Unit ON and OFF	10
Heart Rate Features	11
Guidelines	11
Using the Heart Rate	
Touch-Sensitive Grips	12
Using SmartRate	13
Exercise to Your Target Heart Rate	14

Display Console	15
Scanning and the Display	17
Keypad	17
Changing the Display Features	
Using the SELECT Key	19
Workout Options	21
Choosing QUICKSTART	22
Selecting a User ID	23
Selecting a Program	24
Cooling Down After a Workout	25
Pausing During a Workout or the	
Cool-Down Period	26
Ending a Workout	27

Programs	28
Choosing a Program	28
Program Tips	29
Manual (MANL) Program	30
Walk (WLK_) Programs	30
Run (RUN_) Programs	31
Interval (INTV) Program	31
Random (RAND) Program	32
Weight Loss (WTLS) Program	33
Heart Rate Control (HRC) Program	34
Custom (CST1 or CST2) Programs	35

Advanced Programming and Troubleshooting	37
Advanced Programming Tips	37
Selecting a U.S. Standard or Metric Display	38
Selecting Password Protection	39
Informational Displays	40
Troubleshooting Error Codes	42
Troubleshooting Heart Rate	43

Maintenance	44
Inspection	44
Cleaning the Equipment	44
Storing the Chest Strap	45
Checking the Alignment of the Running Belt	45
Adjusting the Running Belt	46
Servicing the Treadmill	47
Long-Term Storage	47
Precor Residential Equipment Limited Warranty.....	48

Treadmill Safety Features

The treadmill is equipped with certain items that, when used properly, help sustain an enjoyable workout. These items include:

- Security clip
- Password protection
- Handrail
- I/O power switch

Important: Before exercising, review the Important Safety Instructions found at the beginning of this manual.

Using the Security Clip

Attach the security clip to your clothing before each workout. A tug on the lanyard trips the security switch inside the display console and stops the running belt.

If the security switch trips while you are exercising, reattach the security clip to your clothing, enter the password, and press SPEED ▲.

Note: The treadmill retains your workout statistics if you resume your workout within ten minutes.

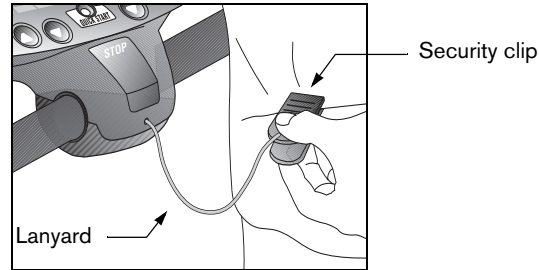

Diagram 3: Attach the security clip to your clothing

Entering the Password

The treadmill provides password protection to help prevent unauthorized use. At the password prompt, press the following key sequence: INCLINE ▼, SPEED ▼, SPEED ▲.

An asterisk appears on the display with each key press. If the correct keys are not pressed within two minutes, the Precor banner appears on the display and the running belt does not move.

Important: Do not assume the treadmill is safe because of password protection. Never leave children unsupervised around the treadmill.

Using the Handrails

To maintain your balance, always grasp a handrail when you step on or off the treadmill, and when you use the keypad.

Turning the Unit ON and OFF

To turn the unit ON and OFF, use the I/O power switch located at the front of the unit, near the power cord. Refer to Diagram 4.

Important: When it is not being used, turn the unit OFF.

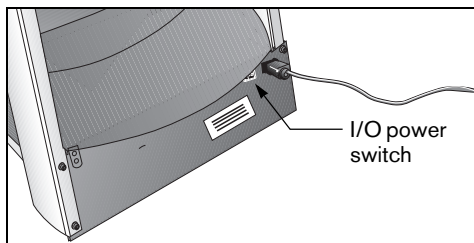
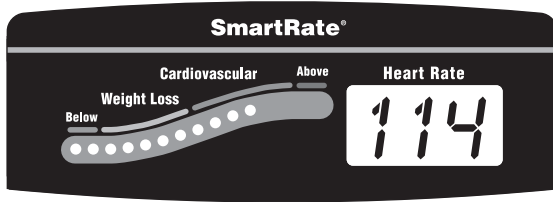

Diagram 4: I/O power switch

Heart Rate Features



Heart rate and SmartRate® features are available when you wear the chest strap or grasp both touch-sensitive handrail grips. When a heartbeat is detected, the Heart Rate display shows your heart rate and the SmartRate LED pulses and indicates your target zone.

Guidelines

Read the following before using the heart rate feature.

- Consult your physician before engaging in any vigorous exercise. Do not use treadmill heart rate features until authorized by your physician.

- Know your heart rate (pulse) and your physician-recommended heart rate target zone. Individual heart rates vary according to several physiological factors and may not correspond directly with Diagram 5.

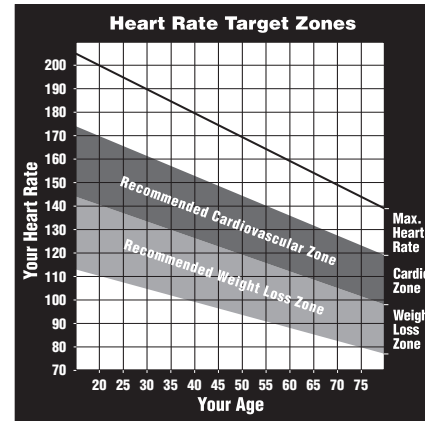

Diagram 5: Heart rate target zones

- The target heart rate is determined using a simple calculation:
(220 minus age) multiplied by 70%

- After you put on the chest strap, face the display console for a minimum of 15 seconds. This allows the receiver in the console to recognize the signal from the chest strap.
- If you prefer to use the hand-held heart rate feature, grasp both touch-sensitive handrail grips and wait five to ten seconds. Your heart rate appears in the Heart Rate display.
- If three dashes (— — —) appear on the display, the treadmill cannot detect a heart rate. Make sure the chest strap is positioned properly around your chest and against your skin. If you are using the touch-sensitive handrail grips, make sure your hands are moist (not dry) and you use both hands.
- Always face forward on the treadmill and use the handrail for balance.

Using the Heart Rate Touch-Sensitive Grips

While exercising, you must grasp both touch-sensitive handrail grips for a minimum of five to ten seconds to transmit your heart rate to the display. Refer to Diagram 6.

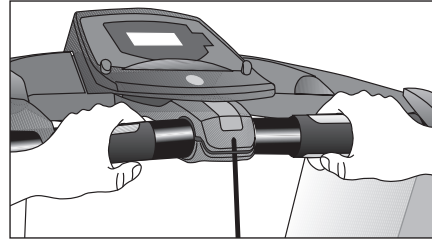

Diagram 6: Touch-sensitive handrail grips

Usually, the concentration of salts in a person's perspiration provides enough conductivity to transmit a signal to the receiver inside the display console. However, some people, because of body chemistry or erratic heart beats cannot use the touch-sensitive handrail grips on the treadmill. A chest strap may provide better results.

Important: *While exercising, do not wear a chest strap and grasp the touch-sensitive handrail grips at the same time. Although the chest strap transmitter overrides signals from the touch-sensitive handrail grips, using both features may cause erratic heart rate readings.*

Using SmartRate

The SmartRate feature helps you monitor and maintain your heart rate in the target zone best suited to your specific needs. All 15 LEDs may light during a workout. When you wear the chest strap, a single LED blinks and indicates the zone that your heart rate is in, either weight loss or cardiovascular.

The 15 LEDs in the SmartRate display are color-coded. A pulsating red LED indicates you are outside the recommended heart rate target zone. Yellow LEDs indicate when you are exercising within the weight loss zone. Green LEDs indicate when you are exercising within the cardiovascular zone.

Refer to Table 1 to see the relationship between the pulsating LED and your target heart rate.

The SmartRate indicator lights do not appear when:

- You press QUICKSTART™ at the banner
- You bypass the AGE prompt
- You do not wear or improperly position the chest strap
- You fail to grasp both touch-sensitive handrail grips for five to ten seconds

Note: Review the information on the QUICKSTART card that accompanies your literature packet. It explains how to adjust the chest strap.

CAUTION: Your heart rate should never exceed 85% of your maximum aerobic heart rate. If it does, immediately reduce your speed or, if possible, adjust the incline to return your heart rate to your physician-recommended target zone.

Table 1. Heart rate target zones and SmartRate LEDs

<i>Heart Rate Target Zone Percent</i>	<i>LED Lit</i>	<i>LED Blinking</i>
Below 50	First	Red
50 to 54	Second	Red
55 to 57	Third	Yellow
58 to 60	Fourth	Yellow
61 to 63	Fifth	Yellow
64 to 66	Sixth	Yellow
67 to 69	Seventh	Yellow
70 to 71	Eighth	Green
72 to 74	Ninth	Green
75 to 76	Tenth	Green
77 to 79	Eleventh	Green
80 to 81	Twelfth	Green
82 to 84	Thirteenth	Green
85 to 87	Fourteenth	Red
Above 87	Fifteenth	Red

Exercise to Your Target Heart Rate

The treadmill includes a program that lets you exercise based on a specified heart rate. You set your target heart rate and the speed of the running belt at the beginning. As you exercise, the Heart Rate Control program monitors your heart rate and automatically maintains it within a few beats per minute (bpm) of your selected target. Your actual heart rate (pulse) appears in the Heart Rate display.

To use this program, select HRC. You must also wear the chest strap so the program can monitor your heart rate throughout the workout. For more information, refer to *Heart Rate Control (HRC) Program*.

Display Console

Center display: When you begin a program, the workout time and program profile appear and remain until the scanning process is initiated.

SmartRate display: LEDs light in this column when the SmartRate feature is activated. Follow the LEDs to monitor your heart rate and maintain it in your target zone.

Heart Rate display: If a heart rate is detected, this area displays your heart rate.

LEDs: Light and clarify what workout statistics appear on the display.

QUICKSTART: Press QUICKSTART to begin your workout immediately. It lets you bypass the setup prompts.

Keypad: Use the keypad to:

- Control your workout session
- Answer prompts prior to starting a program
- Determine which display features appear
- Prematurely end a program
- Adjust the speed or incline

USER 1 or USER 2: Select a user ID (1 or 2) at the Precor banner to personalize your workout session.

SELECT: During your workout, press this key to sequentially scan the features in each column.

Red STOP button: Press to pause a workout.

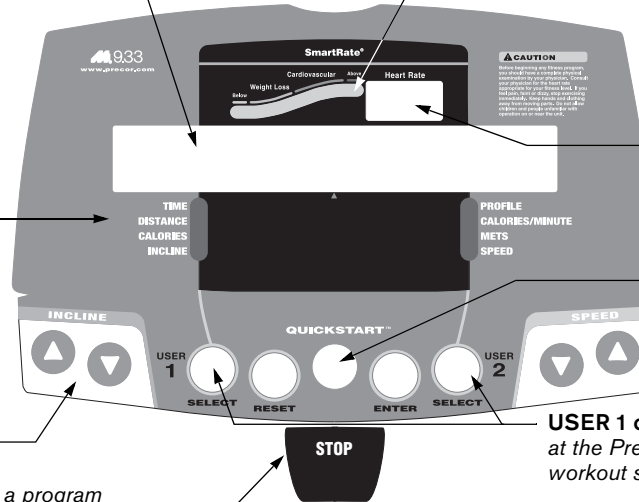

The following information describes the information that appears in the center display. This information is shown in alphabetic order.

CALORIES—displays the estimated cumulative number of calories burned. The calorie calculation is derived from the speed, incline, and your weight. An accurate weight entry results in a more accurate calorie count. When using QUICKSTART and a weight has not been specified, the default weight is 150 pounds (68 kilograms).

CALORIES/MINUTE—displays the approximate number of calories burned per minute.

DISTANCE—shows a linear distance in either miles or kilometers. The distance is calculated based on your speed.

INCLINE—displays the percentage of incline during your workout. The INCLINE ▼ or ▲ keys affect the lift and let you set an incline between 0% and 15%. The values displayed can change in 0.5% increments.

METS—displays the metabolic units associated with your workout.

PROFILE—appears on the display and corresponds to the program you selected. As you continue your workout, a blinking column indicates your position in the program. Changes in incline affect the column height as shown in Diagram 7.

If the profile is only one cell high, then markers (•••••) appear occasionally and provide a sense of movement through the program.

SPEED—displays the running belt speed in miles per hour (mph) or kilometers per hour (kph). The running belt speed ranges from 0.5 to 11 mph (1 to 18 kph) and can be changed in 0.1 increments using the SPEED ▼▲ keys.

TIME—displays workout time during your workout in minutes and seconds; however, when you exceed 60 minutes during a single workout, the TIME display converts to hours and minutes. For programs with a workout time limit, the TIME display shows the amount of time remaining. For programs without a workout time limit, the TIME display indicates the amount of time you have been exercising.

USER 1 and USER 2—Shows the current user selection after a user key has been pressed at the banner. For more information, refer to *Selecting a User ID*.

Scanning and the Display

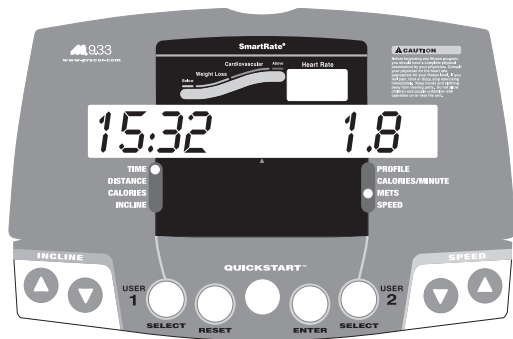

You can conduct scans of your workout statistics by pressing the SELECT key. Each SELECT key affects the column above it. Indicator lights appear next to the feature that is displayed. To select all eight features and activate the scanning mode, refer to *Changing the Display Features Using the SELECT Key*.

Keypad

Use the keypad to enter your workout session selections. Keys on the keypad respond to the slightest touch. Use gentle pressure on the keys as you exercise.

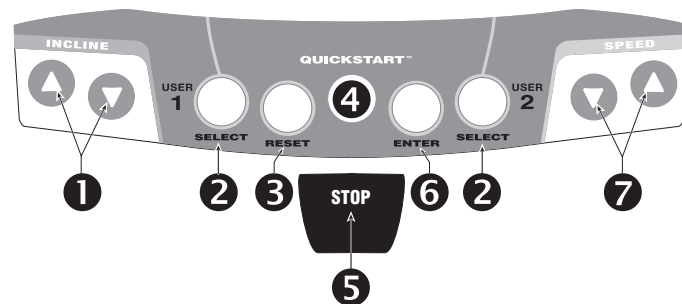

- 1 INCLINE ▼▲:** Press and hold the INCLINE arrows to increase or decrease the incline from 0% to 15% in 0.5% increments.

During your workout, to view your current incline, tap either INCLINE ▲ or ▼ key. To change the incline, press the arrow key for more than one second.

Changes to the incline are not immediate. It takes time for the lift to reach the target incline shown on the display.

The incline setting affects the column height in the program profile as shown in Diagram 7.

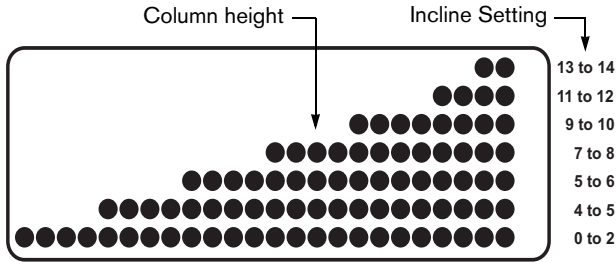

Diagram 7: Column height affected by changes in incline

The height of the column indicates the level of incline. Every time the incline changes by four sequential levels (up or down) the height of the column changes by one row.

Note: During the setup phase, pressing the INCLINE arrow keys will not affect the incline. However, the arrow keys do affect what appears on the display. Refer to *Selecting a Program*.

- 2 SELECT:** The SELECT keys have three functions:
 - To select a user ID before starting a workout. Refer to *Selecting a User ID*.
 - To get specific information during a workout. Each SELECT key affects the column above it. Indicator lights appear next to the item that is displayed.
 - To activate scanning mode and select the information that appears. Refer to *Changing the Display Features Using the SELECT Key*.
- 3 RESET:** During pause mode, press the RESET key to display a WORKOUT SUMMARY. Press RESET again to return to the Precor banner.
- 4 QUICKSTART:** Press QUICKSTART to bypass the setup prompts and start your workout immediately using the Manual program. Refer to *Choosing QUICKSTART*.
- 5 STOP:** A firm tap on the red STOP button slows the running belt to a stop and the treadmill enters pause mode. To resume, enter your password and press the SPEED ▲ key to resume. Refer to *Pausing During a Workout or the Cool-Down Period*.
- 6 ENTER:** Use the ENTER key to confirm responses to workout-specific prompts.

7 SPEED ▼▲: Press and hold the SPEED arrow keys to increase or decrease the running belt speed from 0 to 11 mph (1 to 18 kph) in 0.1 increments.

When you press the arrow keys, a target speed appears in the display. The running belt speed changes to meet the target, but the change occurs gradually so the transition is smooth.

During your workout, to view your current speed, tap either SPEED ▼ or ▲ key. To change the speed, press the arrow key for more than one second.

Note: During the setup phase, you can use the SPEED ▲▼ keys to change the workout session information. Pressing either arrow key does not affect the speed of the running belt at this time.

Changing the Display Features Using the SELECT Key

Use the SELECT key to choose which feature appears on the display. When you begin a program, TIME and PROFILE are preselected and will appear in the center display.

You can display different information while you exercise by pressing the appropriate SELECT key. When the light next to the feature turns on, the information appears in the center display.

The treadmill can scan between a number of the features so you do not need to press a key once scanning is set up. To set up the scanning process, switch the indicator light next to an item on or off. If the indicator light is off, the item will not appear in the display. If the indicator light is on, the treadmill includes it in the scan.

Select TIME, DISTANCE, CALORIES, or INCLINE with the left SELECT key.



Select PROFILE, CALORIES/MINUTE, METS, or SPEED with the right SELECT key.

To add an item to the scanning process:

- Lightly tap the SELECT key until the appropriate indicator lights up. You must then press and hold the SELECT key for at least two seconds. The indicator light blinks until you release the key. During the next scan, the LED lights and the associated information appears.

To turn off an indicator light and remove the item from the scanning process:

- When the indicator light next to the item is lit, press and hold the SELECT key for at least two seconds. The indicator light blinks until you release the key. The next time the treadmill performs a scan, the indicator remains blank and the associated information does not appear.

Workout Options

CAUTION: Before beginning any fitness program, see your physician for a complete physical examination. Know your physician-recommended heart rate target zone.

1. Turn the unit ON. The Precor banner appears in the display.

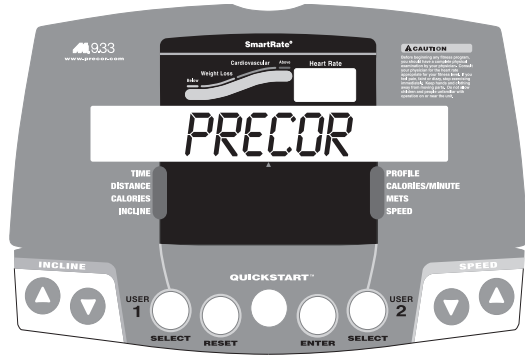

2. Step on the treadmill.
3. Face the display, and then straddle the running belt.
4. Attach the security clip to your clothing.
5. Hold on to the handrail with one hand.

6. Select one of the following options:

Option 1: Use the QUICKSTART key
Choose this option to start your workout immediately. Refer to *Choosing QUICKSTART*.

Option 2: Use the USER1 or USER2 key
Select USER1 or USER2 to personalize your workout session. Preferences are stored with your user ID and reapplied the next time you select the same one. Choosing a user ID enables the treadmill to identify you and remember your last program, workout time, weight, age, and other information specific to the chosen program. A second user ID allows a second person to customize, store, and retrieve workout selections. Refer to *Selecting a User ID*.

Option 3: Use the ENTER key
Choose this option for a customized approach. The display walks you through the preferences for a program, workout time, weight, and age. Workout session information is not retained for future retrieval. Refer to *Selecting a Program*.

Important: If password protection is enabled, you will need to enter a password to begin your workout. At the password prompt, press the following keys in sequence:
INCLINE ▼, SPEED ▼, SPEED ▲.

Choosing QUICKSTART

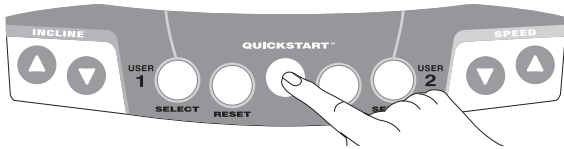

1. Press QUICKSTART at the Precor banner to bypass the setup prompts and access the Manual (MANL) program. QUICKSTART applies the following defaults:

Prompts	Default Value
Program	Manual (MANL)
Time	No limit (INFINITE)
Weight	150 lb (68 kg)
Age	0

To use the SmartRate feature, you need to specify your age. In this case, enter a user ID or press ENTER. Follow the setup prompts to enter your age. Press QUICKSTART after your age is displayed.

Note: To retrieve information about your workout session, select USER 1 or USER 2 at the Precor banner, and then press QUICKSTART. Refer to *Selecting a User ID*.

2. If needed, enter the password by pressing INCLINE ▼, SPEED ▼, and SPEED ▲. An asterisk appears on the display with each entry.
A 3-second countdown appears on the center display, and then the running belt starts moving.
3. Step on to the running belt with the speed at 1 mph (1 kph) and begin your workout. Use the SPEED ▲ to increase the speed of the running belt.

Selecting a User ID

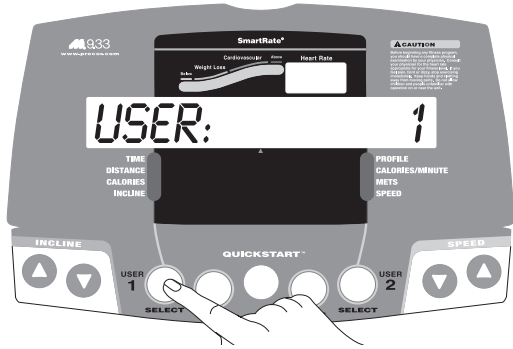

Choosing a user ID enables the treadmill to identify you and track your cumulative workout statistics. It also lets you personalize your workout session and stores information about your preferred program, workout time, weight, and age. Up to two people can select their own user ID and personalize their workout sessions.

Note: Custom programs only appear if you select a user ID.

1. At the Precor banner, press the USER 1 or USER 2 key.
2. When the USER 1 or USER 2 prompt appears, you have two options:

Option 1: Press QUICKSTART

Start your workout using the existing preferences associated with the user ID displayed.

Option 2: Press ENTER

Enter or change your preferences for a program, workout time, weight, age, and other information specific to the chosen program. Workout preferences are saved with your user ID and reapplied to your workout session the next time you select the same user ID.

Important: Press QUICKSTART after any of the prompts (program name, weight, or age entry) to apply existing user ID preferences to any prompts skipped.

3. If needed, enter the password by pressing INCLINE ▼, SPEED ▼, and SPEED ▲. An asterisk appears on the display with each entry.
4. Step on to the running belt and begin your workout. Use the SPEED ▲ to increase the speed of the running belt.

Note: During a workout, the functionality of the SELECT keys change and affect what items appear on the display. Refer to *Changing the Display Features Using the SELECT Key*.

Selecting a Program

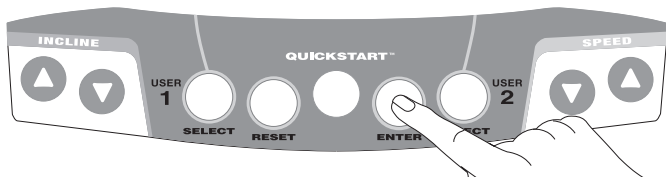

1. At the Precor banner, press ENTER, and then press the arrow keys to cycle through the available programs. The abbreviated program name and a portion of the program profile appear in the display.
2. Select the program you want, and then press ENTER. Refer to Table 2.

Table 2. Available programs

Program Name	Program Abbreviation
Manual	MANL
Walk 1	WLK1
Walk 2	WLK2
Walk 3	WLK3
Run 1	RUN1
Run 2	RUN2
Run 3	RUN3
Interval	INTV
Random	RAND
Weight Loss	WTLS
Heart Rate Control *	HRC
Custom Program 1	CST1
Custom Program 2	CST2

*Requires the chest strap.

3. A program time blinks in the center display. If a time from the previous workout is available, it replaces the default time. Press the arrow keys to select a program time (between 0 and 240 minutes) and then press ENTER.

Note: If you select a zero time limit, INFINITE appears in the display and designates an infinite workout time. If you choose INFINITE, remember to incorporate a cool-down period at the end of your workout.

4. Enter your weight (1–999) and then your age (1–99).
5. To change a value (program, workout time, weight, or age) that you have already entered, press RESET and reenter the information.

Note: You can press QUICKSTART after any of the prompts (program name, workout time, weight, or age entry). QUICKSTART applies the existing preferences and uses default settings for any prompts skipped. If you press QUICKSTART while a program name is displayed, the workout time is automatically set to 30 minutes.

6. Use the INCLINE ▼▲ or SPEED ▲▼ keys to change the incline or speed.

Cooling Down After a Workout

Incorporate a cool-down period into your workout to help lower your heart rate and minimize muscle stiffness or soreness.

When you complete a program with a time limit, calorie goal, or distance goal, you automatically enter a 5-minute cool-down period. The Manual (MANL) program profile appears in the display, the running belt speed is reduced by 20%, and the incline is set to 0%. To adjust the speed or incline, press the arrow keys.

A workout summary appears at the end of the 5-minute cool-down period. See *Ending a Workout*.

Important: *If you press QUICKSTART or enter a time of INFINITE, the automatic 5-minute cool-down period does not occur. If you exit a program before completing it, the cool-down period is bypassed.*

To prematurely end the 5-minute cool-down period, do the following:

1. Grasp the handrail with one hand.
2. Press the red STOP button with your other hand. The treadmill enters pause mode.
3. Press RESET to view the workout summary. The workout summary remains displayed for ten minutes.
4. To return to the Precor banner before the ten minutes elapse, press RESET again.

Pausing During a Workout or the Cool-Down Period

Press the red STOP button to pause anytime during a workout or during a cool-down period. The pause mode is limited to ten minutes. If you do not resume exercising during that time, the display returns to the banner.

Press the RESET key to view the workout summary. Press RESET again to return to the Precor banner.

Note: To resume exercising from pause mode, press SPEED ▲. If password protection is enabled, you are prompted for the password.

Ending a Workout

CAUTION: Hold on to the handrail when you near the end of a workout.

The treadmill stops the running belt when you complete the automatic cool-down period. After the running belt stops, time stops accruing.

The WORKOUT SUMMARY shows your cumulative workout statistics including warm-up and cool-down periods. Other information including speed and incline reset to zero. Toggle between the TIME, DISTANCE, and CALORIES displays using the SELECT key. You can review your workout statistics for ten minutes before the display resets to the banner.

Note: If you choose to work out with no set time limit, you must manually end a program by pressing the red STOP button. You can also press the SPEED ▼ key until the speed is reduced to zero and the running belt stops.

Important: Do not assume the treadmill is safe because of password protection. Never leave children unsupervised around the treadmill.

Programs

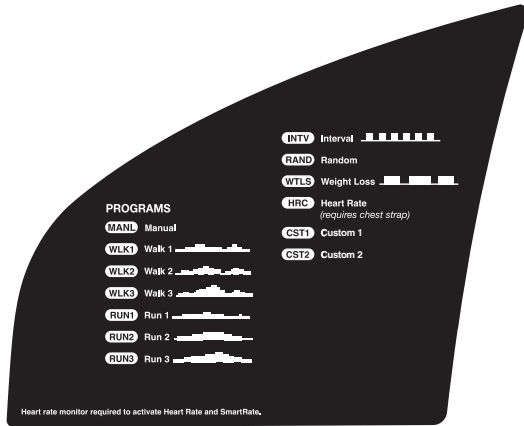

Diagram 8: M9.33 program label

This section describes the programs printed on the display label. Refer to Diagram 8.

Choosing a Program

Choosing a program depends on your goals. If you are a beginner or returning to regular exercise, you can start a cardio-conditioning program to slowly return your body to a comfortable level of exercise. If you have been exercising and feel that you have an intermediate or advanced fitness level, you probably have established goals. The Precor web site (www.precor.com) can give you many ideas about fitness workouts and advice from the experts.

Several workout choices on the treadmill are pre-programmed with recommendations for incline levels, pace, and alternating rest or work intervals. You always have the option to override the suggested levels with the exception of the Heart Rate Control (HRC) program.

If your level of exertion becomes too great, reduce your pace or change the incline using the arrow keys to override each upcoming column in the program profile. If you use the arrow keys, the program profile changes accordingly. When you complete a program that contains a time limit, an automatic 5-minute cool-down period begins.

The table below shows a variety of program options.

Table 3. Program options

<i>Preferences</i>	<i>MANL</i>	<i>WLK_</i>	<i>RUN_</i>	<i>INTV</i>	<i>RAND</i>	<i>WTLS</i>	<i>HRC</i>	<i>CST_</i>
Preset incline		X	X	X, †	X	X, †	X	X, †
Preset speed				X, †		X, †		X, †
Warm-up period							X	
Rest/Work intervals				X		X		
Fixed time limit						X		
Heart rate controlled*							X	
Arrow keys can change speed or incline	X	X	X	X	X	X		X

* Requires the chest strap.

† Indicates programs that store incline and speed preferences.

Program Tips

- Work out indefinitely in any program (except Weight Loss). At the time prompt, specify INFINITE. The TIME display indicates the amount of time you have been exercising. If you choose to exercise without a time limit, the automatic 5-minute cool-down period is eliminated. You will need to incorporate a cool-down period by accessing the Manual program.

- Place a time limit on any program during the setup phase. At the time prompt, specify the time duration for your workout. When you exercise, TIME shows the amount of time remaining.
- A blinking column tracks the progress that you make during a program.

Manual (MANL) Program

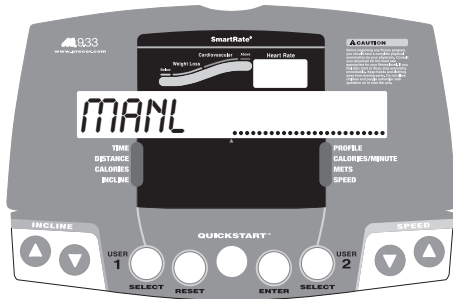

You control speed and incline settings when you use the Manual program. The profile begins as a flat line. Use the arrow keys to change the speed or to adjust the incline. The program profile reflects changes in all subsequent columns. The blinking column indicates your position in the program.

If you press QUICKSTART at the banner and access the Manual program, the workout time is infinite. A cool-down period does not automatically occur when you end your workout. Always remember to incorporate a cool-down period into your workout.

To use the SmartRate feature, you need to specify your age. Refer to *Selecting a Program*.

Walk (WLK_) Programs

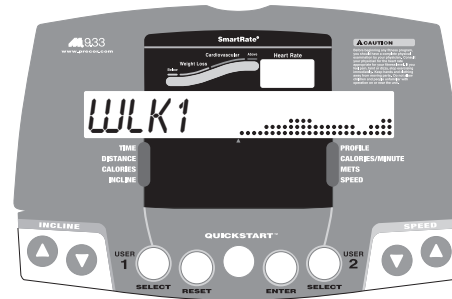

The Walk programs provide varying levels of exertion from an easy walk (WLK1) to a more advanced level (WLK3) and have preprogrammed inclines. The percentage of incline and the frequency with which the profile changes determine the level of difficulty. You can override the incline level by pressing the INCLINE ▼▲ keys. The change is stored in memory.

The running belt's speed is completely under your control. As you move through the program, the column profile repeats until the time limit is reached.

The walk program is a great cardio-conditioning program for beginners and serious walkers alike. Visit our web site www.precor.com, for more information and to supplement your workout with additional plans.

Run (RUN_) Programs

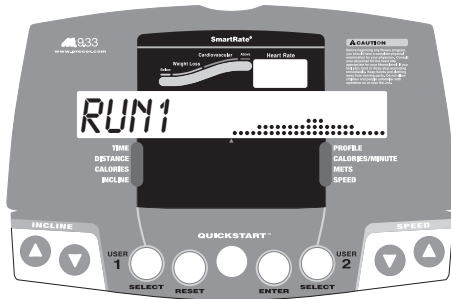

The Run programs provide varying levels of exertion from an easy run (RUN1) to a more advanced level (RUN3) and have preprogrammed inclines similar to the walk programs. The percentage of incline and the frequency with which the profile changes determine the level of difficulty. You can override the incline level by pressing the INCLINE ▼▲ keys. The change is stored in memory.

The running belt's speed is completely under your control. As you move through the program, the column profile repeats until the time limit is reached.

If you are a runner, visit our web site www.precor.com for more information to supplement your workout.

Interval (INTV) Program

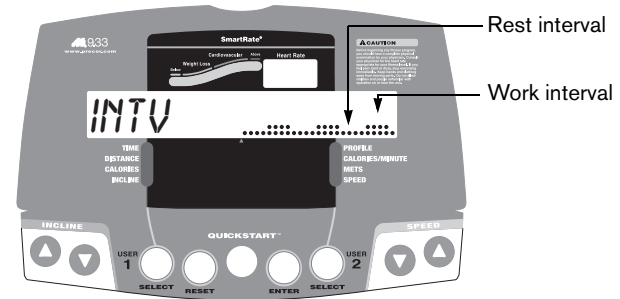

The Interval program is among the best for conditioning your cardiovascular system. The program raises and lowers your level of exertion repeatedly in 1-minute intervals for a specified period of time.

When you select the Interval program, you are prompted to set the duration of the rest and work intervals. To select the displayed number, press ENTER, or change the interval duration from 1 to 9 minutes using the arrow keys.

When you begin the program, set the speed and incline for the first rest and work intervals. The settings are repeated throughout the program.

To change a setting, press the appropriate arrow key and continue. The changes are applied to the remaining intervals. The display lets you know when the speed or incline levels are about to change, and indicates the levels of the next interval.

When you complete the program, the speed and incline settings are saved and applied the next time you select the same Interval program.

Random (RAND) Program

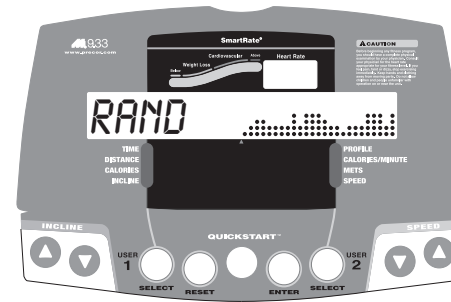

Every time the Random program is selected, a different program profile appears. The columns that appear in the program profile show the preprogrammed incline. You can override the preprogrammed incline at any time using the INCLINE arrow keys.

The incline is preset to zero for the first column. The maximum incline change allowed between columns is plus or minus 4%.

The running belt speed is completely under your control and can be adjusted using the SPEED arrow keys.

Weight Loss (WTLS) Program

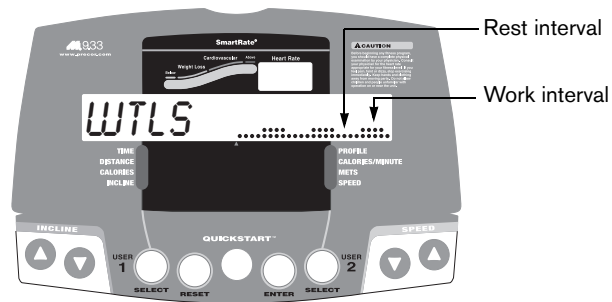

With the Weight Loss program, the workout time is fixed at 28 minutes and consists of seven, 4-minute intervals. You are not prompted for a workout time. Use the arrow keys to set the speed or the incline for the rest or work interval. When you make changes, the program repeats the settings for the remaining intervals.

The display lets you know when the speed or incline levels are about to change, and indicates the levels of the next segment.

For the ideal weight loss range, your heart rate should be between 55% and 70% of your maximum aerobic heart rate. If you wear the chest strap or grasp both touch-sensitive handrail grips, you can use SmartRate as a visual cue.

- Set a comfortable pace and then adjust the incline.
- Maintain a level of exertion so that the yellow LED blinks in the SmartRate display during rest intervals.
- During the work intervals, increase your level of exertion so that the first green LED blinks.

For more information about the SmartRate display, refer to *Using SmartRate*.

Heart Rate Control (HRC) Program

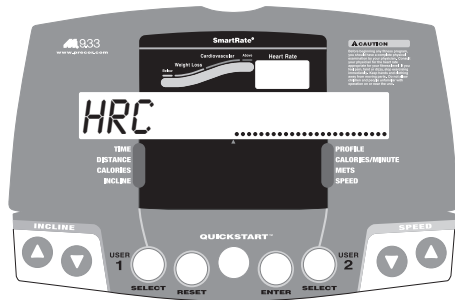

The Heart Rate Control program lets you set a target for your heart rate. The program adjusts the incline to maintain your heart rate within two beats per minute of the target heart rate while you work out. To use this program, you must wear the chest strap so the treadmill can monitor your heart rate throughout the session.

During your workout, the number that represents your heart rate appears in the Heart Rate display.

For information about understanding your target heart rate, refer to *Using SmartRate*.

Important: Consult your physician to determine the appropriate target heart rate for your age and fitness level. If your physician recommends a different target heart rate than the one that appears on the display, use the **INCLINE** arrow keys to change the target heart rate once you finish the warm-up period. Do not work out over the recommended range.

Warm-up Period

The treadmill provides a 3-minute warm-up period. During this time, you may change the speed and incline.

Note: If your heart rate moves into the target heart rate zone during the 3-minute warm-up period, the warm-up period ends and the Heart Rate Control program begins.

Using the HRC Program

When the warm-up period concludes:

- The treadmill automatically adjusts the incline to keep your heart rate at the selected target. Pressing the INCLINE arrow keys no longer affects the lift motor and incline, but does change the target heart rate. Check the SmartRate display to see if you are maintaining your preferred zone (weight loss or cardiovascular). Check the Heart Rate display to determine your actual heart rate.
- You can change the target heart rate, speed, or incline, but doing so affects the unit's ability to maintain your target heart rate in the preferred zone. It takes time for the treadmill to readjust the incline so that your heart rate remains on target.

Note: If you are having difficulty with the heart rate features, refer to *Troubleshooting Heart Rate*.

Custom (CST1 or CST2) Programs

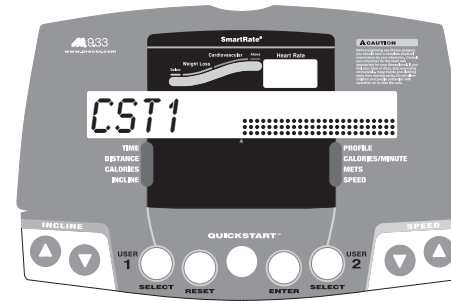

Two custom programs are available with each user ID. As you exercise, you customize the program by determining the speed and incline settings for each 1-minute column along the length of the profile. As each column elapses, the speed and incline for that column is stored in memory.

The subsequent columns repeat the last programmed speed and incline and are reflected in the program profile. Change the speed or incline using the arrow keys. When you complete the program, the settings are automatically recalled using the same user ID and program number.

During the program, the TIME display relates to the amount of time remaining in the recorded columns. Total elapsed time appears when you record new columns.

Note: The length of the custom program and number of speed and incline settings are limited to the available memory in the treadmill. The program will not end if the available memory is exhausted, but the display notifies you, and further changes to speed or incline are not saved. Approximately six hours of recording time is available for the two user IDs.

Clearing the Settings on a Custom Program

Perform the following steps to clear (delete) any speed or incline settings stored in a custom program.

1. At the Precor banner, press USER 1 or USER 2, and then press ENTER.
2. Use any arrow key to specify the custom program (CST1 or CST2) that you wish to clear.

Important: *Clearing the speed and incline settings from a custom program permanently deletes them from memory.*

3. While the program name is blinking, press and hold the SELECT key associated with the user ID specified earlier for ten seconds. After the message CLEARED appears on the display, you can release the key. Speed and incline information are reset to zero.

Note: During the 10-second delay, you can release the SELECT key and no change will occur to the custom program settings.

Advanced Programming and Troubleshooting

Certain features remain hidden and can only be accessed using special key presses. Read this section if you want to:

- Change the display to U.S. Standard or Metric
- Enable or disable password protection
- View the odometer
- Display the number of hours you have used your treadmill
- View the software versions and part numbers
- Check the error log
- Display the serial number

Advanced Programming Tips

- Always start at the Precor banner.
- The advanced programming and diagnostic mode is accessed by pressing the RESET key at the Precor banner. The remaining key presses must occur quickly and without pause.
- Use the ENTER, SELECT and arrow keys while in the diagnostics mode.
- The function of the QUICKSTART key is disabled while in diagnostics mode.
- Exit the diagnostics mode by pressing the RESET key for two or more seconds. The display remains blank for one second and any additional key presses are ignored.

Selecting a U.S. Standard or Metric Display

The treadmill can display measurements in either U.S. Standard (U.S. STD) or METRIC. The default factory setting is set to display U.S. STD. To change this setting, perform the following steps:

1. At the Precor banner, press the following keys in sequence and without pause:

RESET, QUICKSTART, ENTER, SELECT [USER 2], INCLINE ▲

As shown in Diagram 9, numbers are associated with the keypad. The numbers 5, 6, 7, 1 appear on the display as you press the associated key.



Diagram 9: Keypad programming numbers

2. SELECT UNITS appears, followed by the current unit of measure (U.S. STD or METRIC). Use an arrow key to switch between the options.

3. Press ENTER to accept the displayed setting.

The change will be retained in memory even if the treadmill is turned OFF and unplugged.

4. To continue programming the treadmill to change password protection, refer to *Selecting Password Protection*.
5. If you want to end programming, press RESET.

Selecting Password Protection

Note: The password protection program is part of a two-part sequence that starts with the steps found in *Selecting a U.S. Standard or Metric Display*.

6. At the password prompt, specify ENABLED or DISABLED, using the arrow keys to switch between settings.

Setting	Description
Password Enabled	Causes the password prompt to appear prior to a workout and when returning from Pause mode.
Password Disabled	Lets you turn off the password prompt. Use this setting with caution.

CAUTION: Precor recommends that you leave the password protection enabled. If you choose to change the security of the treadmill, it is your responsibility to make sure that no unauthorized personnel or children are allowed on or near the treadmill.

7. Press ENTER to accept the displayed setting.

The change will be retained in memory even when the treadmill is turned OFF and unplugged.

8. To end the programming mode and return to the Precor banner, press RESET.

Informational Displays

The treadmill provides information about its use (odometer and hour meter), as well as software version, error log, and serial number. In general, you would only access this information if directed to do so by Precor Customer Support.

These instructions guide you through all five informational displays. Pressing the ENTER key moves you through the displays. To exit, press the RESET key at any time.

Viewing the Odometer

1. At the Precor banner, press the following keys in sequence and without pause:

RESET, ENTER, QUICKSTART

Numbers 6, 5 appear on the display as you press the associated key.

Then MILES appears on the display followed by the odometer value (the cumulative miles users have traveled).

Note: If the unit of measure is set to metric, then KILOMETERS appears instead of MILES.

2. When you are ready, press ENTER to move to the next display (hour meter).

Viewing the Hour Meter

HOUR METER appears on the display followed by the number of hours that the unit has been in use. The treadmill tracks the elapsed minutes, but the value that appears is truncated to the nearest full hour.

3. When you are ready, press ENTER to move to the next display (software version).

Viewing the Software Version and Part Numbers

SW VERSION appears on the display followed by the upper board software version and part number (for example, 47475-205).

4. To see the lower board's serial number and upper boot part number, use either SELECT key. If needed, you can move through all three—upper board, lower board, and upper boot—using the SELECT keys.
5. Write the numbers in the space below. You will need these numbers when you call Customer Support with display-related questions. This information will help rule out any software-related problems:

Upper Board P/N: _____

Lower Board P/N: _____

Upper Boot Software P/N: _____

- When you are ready, press ENTER to move to the next display (error log).

Viewing the Error Log

ERROR LOG appears on the display followed by the first entry in the error log if there are any errors. Up to ten error codes can be retrieved.

If there are no errors in the log, you will see NO ERRORS displayed.

- To view any additional error codes in the error log, use the arrow keys. Each error code specifies when it occurred, listing the odometer and hour meter values. Refer to Diagram 10.

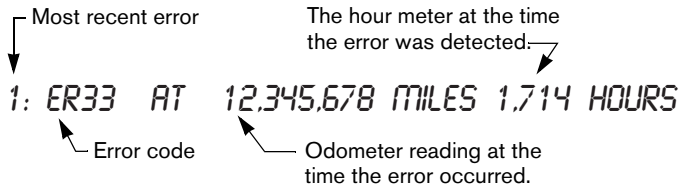

Diagram 10: Error log

- Copy the error code information to paper so you can provide it to Customer Support if needed. Be sure to copy it exactly as shown.
- When you no longer need the information in the error log, press QUICKSTART to erase the error log. While the error log is displayed, maintain light pressure on the QUICKSTART key until CLEAR, and then OK appears.
Important: You cannot retrieve the error log once you have cleared it. You may want to resolve any issues you are experiencing with the treadmill before clearing the error log.
- When you are ready, press ENTER to move to the next display (serial number).

Viewing the Serial Number

SER NUMB appears on the display followed by the 10-digit serial number associated with the treadmill. The serial number is helpful when you contact Customer Support.

Note: If no serial number has been entered, then NONE appears. Use the serial number found on the front panel, near the power cord.

11. If you have not already done so, write the serial number onto the Warranty Registration card. You can also register online at www.precor.com.
12. When you are ready, press ENTER to return to the Precor banner.

Troubleshooting Error Codes

If any error codes appear in the center display, turn the unit OFF and ON. If the error continues to occur, call an authorized service person for assistance. Refer to *Obtaining Service*.

Troubleshooting Heart Rate

Table 4 may help you understand and troubleshoot erratic heart rate readings.

Important: A heart rate can only be detected when the Precor heart rate receiver is properly installed in the display and the treadmill is turned ON. You must also wear the chest strap or hold onto both touch-sensitive handrail grips.

Table 4. Erratic heart rate readings

<i>What appears on the display</i>	<i>Cause</i>	<i>What to Do</i>
NO HR RCVR	The heart rate receiver is not installed or it has been disconnected.	To reinstall the heart rate receiver, call Customer Support at 1-800-347-4404.
-- --	A heart rate is not detected.	Be sure the chest strap is in direct contact with your skin. If using the grips, use both hands and make sure your hands are moist not dry.

<i>What appears on the display</i>	<i>Cause</i>	<i>What to Do</i>
Pulsing HR LED	The LED lights briefly when a heart beat is detected.	If the LED is pulsating, it indicates that the heart rate equipment is working properly.
Flickering NO HR RCVR and U --- and F ---	Intermittent heart rate cable connection	Ensure the heart rate cables are properly connected. For additional help, call Customer Support at 1-800-347-4404.

Note: To conduct electrical impulses from a user's heart, both touch-sensitive handrail grips must be grasped firmly for five to ten seconds. Usually, the concentration of salts in a person's perspiration provides enough conductivity to transmit a signal to the receiver in the display console. However, because of body chemistry or erratic heartbeats, some people cannot use the heart rate feature. A chest strap may provide better results. Refer to the *QuickStart Card* for proper placement of the chest strap.

Maintenance

It is important to perform the minor maintenance tasks described in this section. Failure to maintain the treadmill as described here could void the Precor Limited Warranty.

DANGER To reduce the risk of electrical shock, always unplug the unit from its power source before cleaning it or performing any maintenance tasks.

Inspection

Inspect the treadmill daily.

1. Look and listen for slipping belts, loose fasteners, unusual noises, worn or frayed power cords, and any other indications that the equipment may be in need of service. If you notice any of these, obtain service.

Important: If you determine that the treadmill needs service, ensure that the treadmill cannot be used inadvertently. Turn the unit OFF, and then unplug the power cord from its power source. Make sure other users know that the treadmill needs service.

2. Check for worn, frayed or missing security lanyards. Replace missing or worn safety lanyards immediately. Do not exercise on the treadmill without attaching the security clip to your clothing.

To order parts or to contact a Precor authorized service provider in your area, refer to *Obtaining Service*.

Cleaning the Equipment

Most of the working mechanisms are protected inside the hood and base of the treadmill. However, for efficient operation, the treadmill relies on low friction. To keep the friction low, the unit's running belt, staging platforms, and internal mechanisms must be as clean as possible.

Precor recommends the treadmill be cleaned before and after each workout. Use mild soap and water to dampen a soft cloth and wipe all exposed surfaces. This helps remove any dust or dirt.

CAUTION: Do not use any acidic cleaners. Doing so will void the Precor Limited Warranty. Never pour water or spray liquids on any part of the treadmill. Allow the treadmill to dry completely before using.

Periodically, clean the running belt using a soft nylon scrub brush. Frequently vacuum the floor underneath the unit to prevent the accumulation of dust and dirt, which can affect the smooth operation of the unit.

Storing the Chest Strap

Store the chest strap where dust and dirt cannot accumulate on it, such as a closet or drawer. Be sure to keep the chest strap protected from extremes in temperature. Do not store it in an area that may be exposed to temperatures below 32° F (0° C).

To clean the chest strap, use a sponge or soft cloth dampened in mild soap and water. Dry the surface thoroughly with a clean towel.

Checking the Alignment of the Running Belt

Proper belt alignment allows the belt to remain centered and ensures smooth operation. Realigning the belt takes a few simple adjustments. If you are unsure about this procedure, call Precor Customer Support. Refer to *Obtaining Service*.

CAUTION: Special care must be taken when aligning the running belt. Turn OFF the treadmill while adjusting or working near the rear roller. Remove any loose clothing and tie back your hair. Be very careful to keep your fingers and any other object clear of the belt and rollers, especially in front of the roller and behind the deck. The treadmill will not stop immediately if an object becomes caught in the belt or rollers.

1. The treadmill has adjustable rear feet. Make sure that the running surface is level. If the treadmill is placed on an uneven surface, adjusting the rear feet can help, but will not compensate for extremely uneven surfaces.
2. Turn the unit ON.
3. Stand beside the treadmill and press QUICKSTART.
4. If needed, enter the password by pressing the following keys in sequence INCLINE ▼, SPEED ▼, SPEED ▲.

The running belt starts automatically after a 3-second countdown appears on the display.

5. Press the SPEED ▲ key until the display shows a speed of 3 mph (5 kph).

CAUTION: If you hear any chafing or the running belt appears to be getting damaged, stop the running belt immediately by pressing the red STOP button. Contact Precor Customer Support.

6. Walk around to the rear of the unit and observe the belt for a few minutes. The belt should be centered on the running belt. If the belt drifts off center, you must make adjustments.

Important: If the belt needs alignment, make the adjustments at once. Failure to align the belt may cause the belt to tear or fray, which is not covered by the Precor Limited Warranty.

7. To stop the running belt, press the red STOP button.
8. Turn the treadmill OFF.

Adjusting the Running Belt

If you are unsure about adjusting the running belt, call Precor Customer Support (refer to *Obtaining Service*).

CAUTION: To ensure your safety, use the I/O power switch to turn OFF the treadmill before making any adjustments. Do not adjust the running belt when someone is standing on the unit.

1. Locate the right belt adjustment bolt in the rear end cap of the treadmill. Refer to Diagram 11.

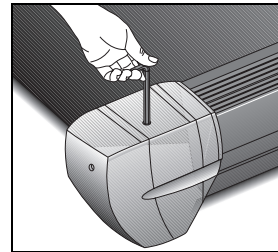

Diagram 11: Adjusting belt location

To determine left and right, stand at the rear of the treadmill and face the display. Make all belt adjustments on the right rear corner bolt using the hex key provided.

- If the belt is off center to the LEFT, turn the adjusting bolt $\frac{1}{4}$ turn *counterclockwise*, which moves the running belt to the right.
- If the belt tracks off center to the RIGHT, turn the bolt $\frac{1}{4}$ turn *clockwise*; this moves the belt to the left.

Important: Do not turn the adjusting bolt more than $\frac{1}{4}$ turn at a time. Overtightening the bolt can damage the treadmill.

2. Recheck the alignment of the running belt.

Servicing the Treadmill

Do not attempt to service the treadmill yourself except for the maintenance tasks described in this manual. The unit does not contain any user-serviceable parts that require lubrication. For information about product operation or service, call 1-800-347-4404.

Long-Term Storage

When the treadmill is not in use for any length of time, turn it OFF. Ensure that the power cord is unplugged from its power source and is positioned so that it will not become damaged or interfere with people or other equipment.

Precor Residential Equipment Limited Warranty

PLEASE READ THESE WARRANTY TERMS AND CONDITIONS CAREFULLY BEFORE USING YOUR PRECOR INCORPORATED PRODUCT. BY USING THE EQUIPMENT, YOU ARE CONSENTING TO BE BOUND BY THE FOLLOWING WARRANTY TERMS AND CONDITIONS.

Limited Warranty

Precor Incorporated warrants all new Precor products to be free from defects in materials and manufacture for the warranty period set forth below. The warranty period commences on the invoice date of original purchase. This warranty applies only against defects discovered within the warranty period and extends only to the original purchaser of the product. Parts repaired or replaced under the terms of this warranty will be warranted for the remainder of the original warranty period only. To make claim under warranty, the buyer must notify Precor or their authorized Precor dealer within 30 days after the date of discovery of any nonconformity and make the affected product available for inspection by Precor or its service representative. Precor's obligations under this warranty are limited and set forth below.

Warranty Periods and Coverage

All residential products and commercial products used in the home are warranted for the following periods:

- Lifetime frame and welds
- 10 years parts and wear items
- 1 year labor
- Coverage for options and accessories defined below.

Options / Accessories

Many options or accessories have components that are connected internally or mounted inside the electronic console. The following guidelines determine the warranty for these components. If the internal components are installed by the factory or by an authorized dealer as part of the original sale and delivery, they have a warranty that is identical to the warranty of the equipment in which they are connected or mounted. If the internal components are not installed by the factory or by an authorized dealer as part of the original sale and delivery, they have a 90-day parts and labor limited warranty. All components that are not internally connected have 90-day parts only limited warranty. Satisfactory proof of purchase is required in all cases.

Conditions and Restrictions

This warranty is valid only in accordance with the conditions set forth below:

1. The warranty applies to the Precor product only while:
 - a. It remains in the possession of the original purchaser and proof of purchase is demonstrated
 - b. It has not been subjected to accident, misuse, abuse, improper service, or non-Precor modifications
 - c. Claims are made within the warranty period
2. This warranty does not cover damage or equipment failure caused by electrical wiring not in compliance with electrical codes or Precor owner's manual specifications, or failure to provide reasonable and necessary maintenance as outlined in the owner's manual.
3. Warranty of all Precor products applies to residential use only and is void when products are used in a nonresidential environment or installed in a country other than where sold.
4. Except in Canada, Precor does not pay labor outside the United States.
5. Warranties outside the United States and Canada may vary. Please contact your local Dealer for details.

This limited warranty shall not apply to:

1. Software version upgrades
2. Cosmetic items, including, but not limited to the following: grips, seats, and labels.
3. Repairs performed on Precor equipment missing a serial number or with a serial tag that has been altered or defaced.

4. Service calls to correct installation of the equipment or instruct owners on how to use the equipment.
5. Pickup, delivery, or freight charges involved with repairs.
6. Any labor costs incurred beyond the applicable labor warranty period.

Disclaimer and Release

The warranties provided herein are the exclusive warranties given by Precor and supersede any prior, contrary or additional representations, whether oral or written. ANY IMPLIED WARRANTIES, INCLUDING THE WARRANTY OF MERCHANTABILITY OR FITNESS FOR A PARTICULAR PURPOSE THAT APPLY TO ANY PARTS DESCRIBED ABOVE ARE LIMITED IN DURATION TO THE PERIODS OF EXPRESS WARRANTIES GIVEN ABOVE FOR THOSE SAME PARTS. PRECOR HEREBY DISCLAIMS AND EXCLUDES THOSE WARRANTIES THEREAFTER. Some states do not allow limitation on how long an implied warranty lasts, so the above limitation may not apply to you. PRECOR ALSO HEREBY DISCLAIMS AND EXCLUDES ALL OTHER OBLIGATIONS OR LIABILITIES, EXPRESS OR IMPLIED, ARISING BY LAW OR OTHERWISE, WITH RESPECT TO ANY NONCONFORMANCE OR DEFECT IN ANY PRODUCT, INCLUDING BUT NOT LIMITED TO: (A) ANY OBLIGATION, LIABILITY, RIGHT, CLAIM OR REMEDY IN TORT, WHETHER OR NOT ARISING FROM THE NEGLIGENCE OF PRECOR OR ITS SUPPLIERS (WHETHER ACTIVE, PASSIVE OR IMPUTED); AND (B) ANY OBLIGATION, LIABILITY, RIGHT, CLAIM, OR REMEDY FOR LOSS OF OR DAMAGE TO ANY EQUIPMENT. This disclaimer and release shall apply even if the express warranty set forth above fails of its essential purpose.

Exclusive Remedies

For any product described above that fails to conform to its warranty, Precor will provide, at their option, one of the following: (1) repair; (2) replacement; or (3) refund of the purchase price. Precor Limited Warranty service may be obtained by contacting the authorized dealer from whom you purchased the item. Precor compensates Servicicers for warranty trips within their normal service area to repair equipment at the owner's location. You may be charged a trip charge outside the service area. THESE SHALL BE THE SOLE AND EXCLUSIVE REMEDIES OF THE BUYER FOR ANY BREACH OF WARRANTY.

Exclusion of Consequential and Incidental Damages

PRECOR AND/OR ITS SUPPLIERS SHALL HAVE NO OBLIGATION OR LIABILITY, WHETHER ARISING IN CONTRACT (INCLUDING WARRANTY), TORT (INCLUDING ACTIVE, PASSIVE, OR IMPUTED NEGLIGENCE AND STRICT LIABILITY), OR OTHERWISE, FOR DAMAGE TO THE EQUIPMENT, PROPERTY DAMAGE, LOSS OF USE, REVENUE OR PROFIT, COST OF CAPITAL, COST OF SUBSTITUTE EQUIPMENT, ADDITIONAL COST INCURRED BY BUYER (BY WAY OF CORRECTION OR OTHERWISE) OR ANY OTHER INCIDENTAL, SPECIAL, INDIRECT, OR CONSEQUENTIAL DAMAGES, WHETHER RESULTING FROM NONDELIVERY OR FROM THE USE, MISUSE OR INABILITY TO USE THE PRODUCT. This exclusion applies even if the above warranty fails of its essential purpose and regardless of whether such damages are sought for breach of warranty, breach of contract, negligence, or strict liability in tort or under any other legal theory. Some states do not allow the exclusion or limitation of incidental or consequential damages, so the above limitation might not apply.

This warranty gives you specific legal rights, and you may also have other rights, which vary state to state.

Effective 01 January, 2003
P/N 36287-110

Thank You and Welcome to Precor

PRECOR[®] USA
move beyond[®]

To allow us to serve you better, please take a few moments to complete and return your warranty registration.

YOU MAY ALSO REGISTER ONLINE AT

www.precor.com/warranty

If you have questions or need additional information, contact your local dealer or call Precor Customer Support at 800-347-4404.

Fold along dotted line and tape closed before mailing.

RET.

PRECOR[®] USA
Precor Incorporated
20031 142nd Avenue NE
PO Box 7202
Woodinville, WA 98072-4002

PLACE
STAMP
HERE

TELL US ABOUT YOUR NEW PRECOR PRODUCT

Date of Purchase:

Month	Day	Year
-------	-----	------

Product Serial Number:

--	--	--	--	--	--	--	--	--	--

The serial number is located on the shipping box and on the product.

Purchased from:

--	--	--	--	--	--	--	--	--	--

Dealer Name

Please indicate the type of product purchased:

- | | |
|---|--|
| <input type="checkbox"/> Elliptical Fitness CrossTrainer (EFX®) | <input type="checkbox"/> StretchTrainer™ |
| <input type="checkbox"/> Treadmill | <input type="checkbox"/> Cycle |
| <input type="checkbox"/> Strength Training System | <input type="checkbox"/> Stair Climber |

TELL US ABOUT YOU

<input type="checkbox"/> Mr.										
<input type="checkbox"/> Mrs.										
<input type="checkbox"/> Ms.										

First Name

Middle Initial

Last Name

Street Address

Apt./Suite:

City

State

Zip Code

Area Code

Telephone

Your Email Address

Gender:

- Male
 Female

Marital status:

- Married
 Divorced
 Widowed
 Never been married

Age:

- Under 18
 18-24
 25-34
 35-44
 45-54
 55-64
 65+

Annual household income:

- Under \$50,000
 \$51,000-75,000
 \$76,000-100,000
 \$101,000-150,000
 \$151,000+

What are your fitness goals?

- Weight loss/management
 Muscle tone enhancement
 Cardiovascular improvement
 Overall health
 Increase energy and flexibility
 Stress reduction
 Rehabilitation
 Other

TELL US ABOUT YOUR PURCHASE

Purchase (check all that apply):

- First Precor product
 Replaces a Precor product of the same type
 Replaces same type of product – different brand
 Addition to equipment currently owned

What factors MOST influenced your decision to purchase your Precor product (choose up to three):

- Precor reputation
 Prior use of Precor product(s)
 Design/appearance
 Value for the price
 Special product features
 Rebate or sale price
 Quality/durability
 Warranty
 Physician recommendation

How did you FIRST become aware of Precor products (choose only one):

- A gift
 Friend/relative
 Physician
 Fitness club
 Internet
 News report or product review
 Magazine advertisement or article
 Print advertisement
 In-store display or demonstration
 Other

Please detach and mail in the warranty registration within ten days of purchase.

M9.33 Low Impact Treadmill

Product Specifications

Length:	79 in (201 cm)
Width:	34 in (84 cm)
Height:	55 in (140 cm)
Weight:	285 lb (130 kg)
Shipping weight:	350 lb (159 kg)
Running surface:	57 in x 20 in (145 cm x 51 cm)
Motor:	2.75 hp Continuous duty
Power:	120 VAC, 50/60Hz
Speed:	0.5–11 mph (1–18 kph)
Incline:	0%–15% grade
Frame:	Powder-coated steel
Regulatory Approvals:	FCC, ETL, CE

Product Features

CSAFE compatible
QuickStart™
Reversible Deck
SmartRate*
Touch-Sensitive Display
Heart Rate Telemetry (chest strap included)
Two User IDs
Password Protection

M9.33 Programs:

Custom 1	Run 1
Custom 2	Run 2
Fitness Test	Run 3
Heart Rate*	Walk 1
Interval	Walk 2
Manual	Walk 3
Random	Weight Loss*

Display Readouts:

Calories	METs
Calories per Minute	Profile
Distance	SmartRate*
Heart Rate*	Speed
Incline	Time

* Chest strap required.

Precor, C, CrossRamp, EFX, M, Move Beyond, and SmartRate are registered trademarks of Precor Incorporated. Crosstrainer, QuickStart, and StretchTrainer are trademarks of Precor Incorporated. Copyright 2004 Precor Incorporated. Specifications subject to change without notice.
www.precor.com

NOTICE:

Precor is widely recognized for its innovative, award winning designs of exercise equipment. Precor aggressively seeks U.S. and foreign patents for both the mechanical construction and the visual aspects of its product design. Any party contemplating the use of Precor's product designs is hereby forewarned that Precor considers the unauthorized appropriation of its proprietary rights to be a very serious matter. Precor will vigorously pursue all unauthorized appropriation of its proprietary rights.



Precor Incorporated
20031 142nd Ave NE
P.O. Box 7202
Woodinville, WA USA 98072-4002

M9.33 48204-102, en
Warranty # 36287-110, en
Registration Card# 45623-102, en
04 November 2004

QUICKSTART™

PRECOR® USA
move beyond®

CAUTION: Before using the treadmill, read all these instructions. Failure to do so may result in serious injury.

- Do not allow people unfamiliar with its operation, or children, on or near the treadmill.
- Consult with your physician and receive a thorough physical examination. Know your physician-recommended heart rate target zone.
- At the beginning of a workout, straddle the belt by placing your feet firmly on the right and left staging platforms.
- Always face the display and use the handrail for balance. Never attempt to turn around on the treadmill while the running belt is moving.
- Keep hands and clothing away from the belt and rear roller.
- If you feel pain, faintness, or dizziness, stop exercising immediately.

Use the Security Clip

Always attach the security clip to your clothing before each workout. A tug on the lanyard trips the security switch inside the display and stops the running belt. If the security switch trips while you are exercising, the treadmill retains your workout statistics and enters pause mode. To resume your workout, reattach the security clip to your clothing, enter the password, and then press the SPEED ▲ key.

 9.31
 9.33
 9.35
Low-Impact Treadmills

Workout Tips

- Before and after a workout, gently stretch your lower body and back to help prevent stiffness or soreness.
- At the beginning of a workout, take several minutes to bring your heart rate into your target zone (shown in Diagram D on the other side of this card).
- Incorporate a cool-down period into your workout to help lower your heart rate and minimize muscle stiffness or soreness.
- Keys on the keypad respond to the slightest touch. Use gentle pressure on the keys as you exercise.
- If your treadmill supports the hand-held heart rate feature, use both hands to grasp the touch-sensitive handrail grips to display your heart rate.

Begin Your Workout with QUICKSTART

1. Turn ON the treadmill, using the I/O power switch on the front panel.
2. Step on the treadmill.
3. Face the display and straddle the running belt.
4. Attach the security clip to your clothing.
5. Hold on to the handrail with one hand.
6. Press QUICKSTART.
7. If needed, enter the password. Refer to your owner's manual.
A 3-second countdown appears, and then the running belt starts moving. The Manual program begins.
Note: If you prefer a different program, refer to your owner's manual.
8. Step on to the running belt with the speed at 1 mph (1 kph), and begin your workout.
 - To increase the belt speed, press SPEED ▲.
 - To increase or decrease the incline or speed, use the INCLINE ▲ ▼ or SPEED ▲ ▼ keys.
 - To pause, press the red STOP button.
9. Enter a cool-down phase by lowering the speed and incline. End your workout by pressing the red STOP button.
10. Press RESET to display your workout summary. The display shows your cumulative time, distance, and the number of calories burned during your workout.
11. Remove the security clip from your clothing and hold on to the handrail as you step off the treadmill.
12. To prevent unauthorized use, turn the treadmill OFF.

Choose a Program

- Determine your level of fitness: beginner, intermediate, or advanced.
- Determine your immediate goal: endurance training, cardio-conditioning, or weight loss.

If you are a beginner, start a cardio-conditioning program to slowly adjust your body to a comfortable level of exercise. Over a recommended 8-week period, you will increase your endurance and strength while improving flexibility.

If you have been exercising and feel that you have reached an intermediate or advanced fitness level, you probably have established goals for yourself.

For all fitness levels, plan to exercise at a comfortable pace for 20 to 30 minutes a day. Wear a chest strap to monitor your heart rate. Supplement your plans with fitness workouts from the Precor website (www.precor.com). The Precor website provides numerous fitness workouts and expert advice to help you reach your fitness goals.

Wear a Chest Strap

During a workout, the heart rate features appear on the display when you wear a chest strap. To receive an accurate reading, the strap needs to be in direct contact with your skin. Be sure to wear the chest strap underneath your clothing.

Note: The Precor heart rate receiver must be properly installed in the display console before a heartbeat can be detected. Check with your dealer to make sure it is installed in your product.

1. Carefully dampen the back of the strap with tap water (Diagram A).

Important: Do not use deionized water. It does not have the proper minerals and salts to conduct electrical impulses.

2. Adjust the strap and fasten it around your chest. The strap should feel snug, not restrictive (Diagram B).
3. Make sure that the chest strap is right side up, lies horizontally across your chest, and is centered in the middle of your chest (Diagram C).

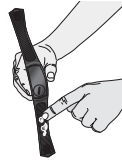

Diagram A

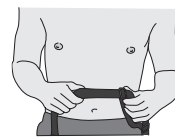

Diagram B

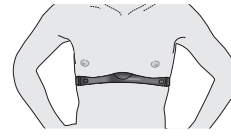

Diagram C

When these steps are complete, you are ready to view your heart rate!

SmartRate® and Heart Rate Features

The SmartRate and heart rate displays provide visual cues that help you adjust your fitness routine to reach your goals. Use these features to keep your heart rate within the target zones for weight loss or cardio-conditioning.

When you begin a workout, a blinking segment in the SmartRate display appears if you entered your age during the setup phase. The blinking segment indicates the current zone of your heart rate: weight loss or cardiovascular. For the ideal weight loss range, your heart rate should remain between 55% and 70% of your maximum aerobic heart rate. To improve your overall cardiovascular and respiratory fitness level, maintain your heart rate between 70% and 85% of your maximum aerobic heart rate.

For the greatest benefits, maintain your heart rate in either zone (weight loss or cardiovascular) for 30 minutes or more at least three times a week.

CAUTION: Your heart rate should never exceed 85% of your maximum aerobic heart rate or go above your target zone (Diagram D).

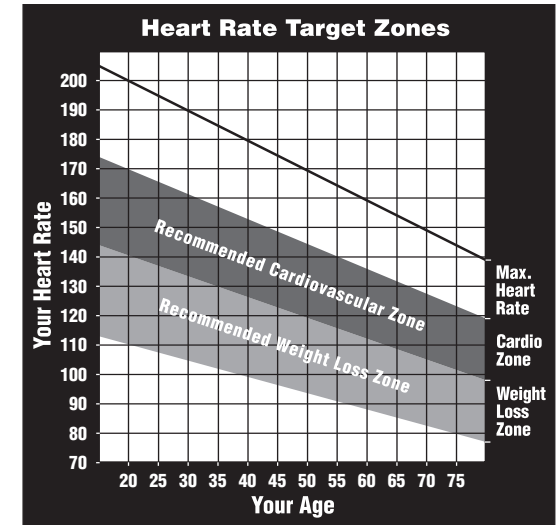

Diagram D

Cool Down After Your Workout

Cooling down is an important aspect of your workout because it helps reduce muscle stiffness and soreness by transporting excess lactic acid out of the working muscles. Cooling down for at least three minutes helps provide a smooth transition that allows your heart rate to return to its normal, non-exercising state.

Assembly Guide



PRECOR[®] USA
move beyond[®]

/// 9.31

/// 9.33

/// 9.35

Low-Impact Treadmills

Thank you for choosing Precor. For proper installation, please read this guide thoroughly and follow the assembly instructions. If you do not assemble the treadmill according to these guidelines, you could void the Precor Limited Warranty.

Obtaining Service

You should not attempt to service the treadmill except for minor belt adjustments and maintenance as described in the owner's manual. For information about product operation or service, refer to the Precor web site at www.precor.com or call Precor Customer Support at 1-800-347-4404. If any items are missing, contact the dealer from whom you purchased the unit or call 1-800-4-PRECOR for the dealer nearest you.

Unpacking the Equipment

The treadmill is carefully tested and inspected before shipment. The unit is shipped in one box. Ask for help from two or more people to unpack and assemble the treadmill.

Required Tools







- 1/2-inch box end or crescent wrench
- String
- Tape
- Wire tie cutter

Installation Requirements

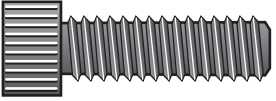
Follow these installation requirements when assembling the unit:

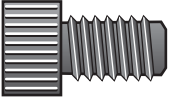
- **Assemble the unit near the location where you plan to use it.**
- **Provide ample space around the unit.**
Open space around the unit allows for easier access.
- **Set up the unit on a solid, flat surface.**
A smooth, flat surface under the unit helps keep it level. A level unit has fewer malfunctions.
- **Open the box and assemble the components in the sequence presented in this guide.**
- **Insert all bolts in the same direction.**
For aesthetic purposes, insert all the bolts in the same direction unless specified (in text or illustrations) to do otherwise.
- **Leave room for adjustments.**
Tighten fasteners (bolts, nuts, and screws), so the unit is stable, but leave room for adjustments. Do not fully tighten fasteners until instructed to do so.

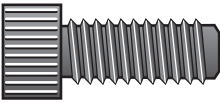
Hardware Kit

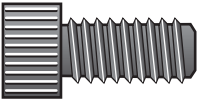
Fasteners		Quantity
	(A) Socket head screw (2-inch)	4
	(B) Barrel spacer	4
	(C) Socket head screw ($\frac{3}{4}$ -inch)	10
	(D) Washer ($\frac{5}{16}$ -inch x .562 OD)	16
	(E) Socket head screws (1 $\frac{1}{4}$ -inch)	2
	(F) Washer ($\frac{5}{16}$ -inch x .688 OD)	4
	(G) Socket head screw (1-inch)	4

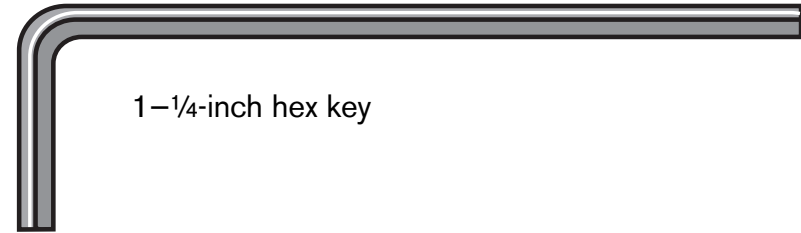

1- $\frac{1}{4}$ -inch hex key

Assembly Steps

- 1** Use a 1/4-inch hex key and 1/2-inch box end wrench to remove the four shipping fasteners on the front panel. Discard the fasteners.

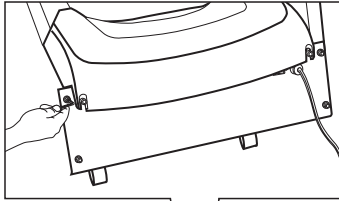

- 2** Unwrap the cable and feed it through the right side upright. Tape the cable to the top.

- 3** Place the right side upright into the base frame side bracket. Secure the upright to the front panel using two socket head screws (C). Secure the upright to the side bracket using two socket head screws (A), two washers (D), and two barrel spacers (B). Finger tighten.

Important: Do not stretch, crimp, or damage the cable. Cables damaged by improper installation will not be covered by the Precor Limited Warranty.

- 4** Place the left side upright into the base frame side bracket. Secure the upright to the front panel using two socket head screws (C). Secure the upright to the side bracket using two socket head screws (A), two washers (D), and two barrel spacers (B). Finger tighten.

- 5** Attach the display console using four socket head screws (G) and four washers (D). Finger tighten.

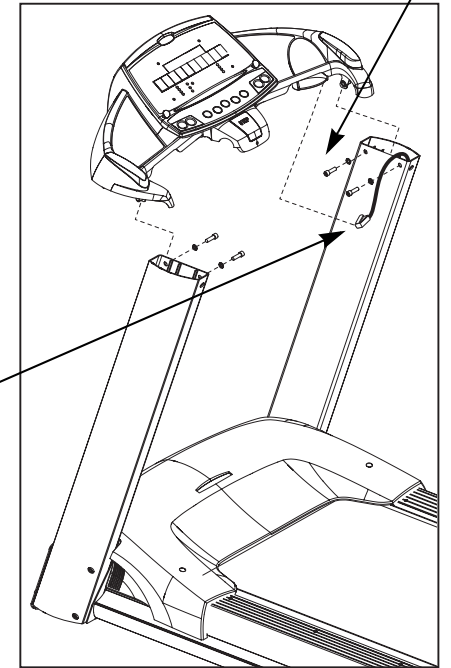

- 6** Hold the cable while you remove the tape. Connect the cable to its receptacle. Slide the cable into the clip on the underside of the display console.

7

To install the handrail, raise the incline.

CAUTION: Do not stand on the treadmill while raising the incline.

- a. Plug the treadmill into a power outlet. Locate the I/O power switch on the front panel and turn the unit ON.
- b. Stand beside the treadmill and press QUICKSTART. If you are prompted for a password, press INCLINE ▼, SPEED ▼, SPEED ▲.
- c. When the running belt begins moving, press the INCLINE ▲ key until the display shows an incline of 15.
- d. When the lift stops moving, press the red STOP button, and then turn the treadmill OFF.

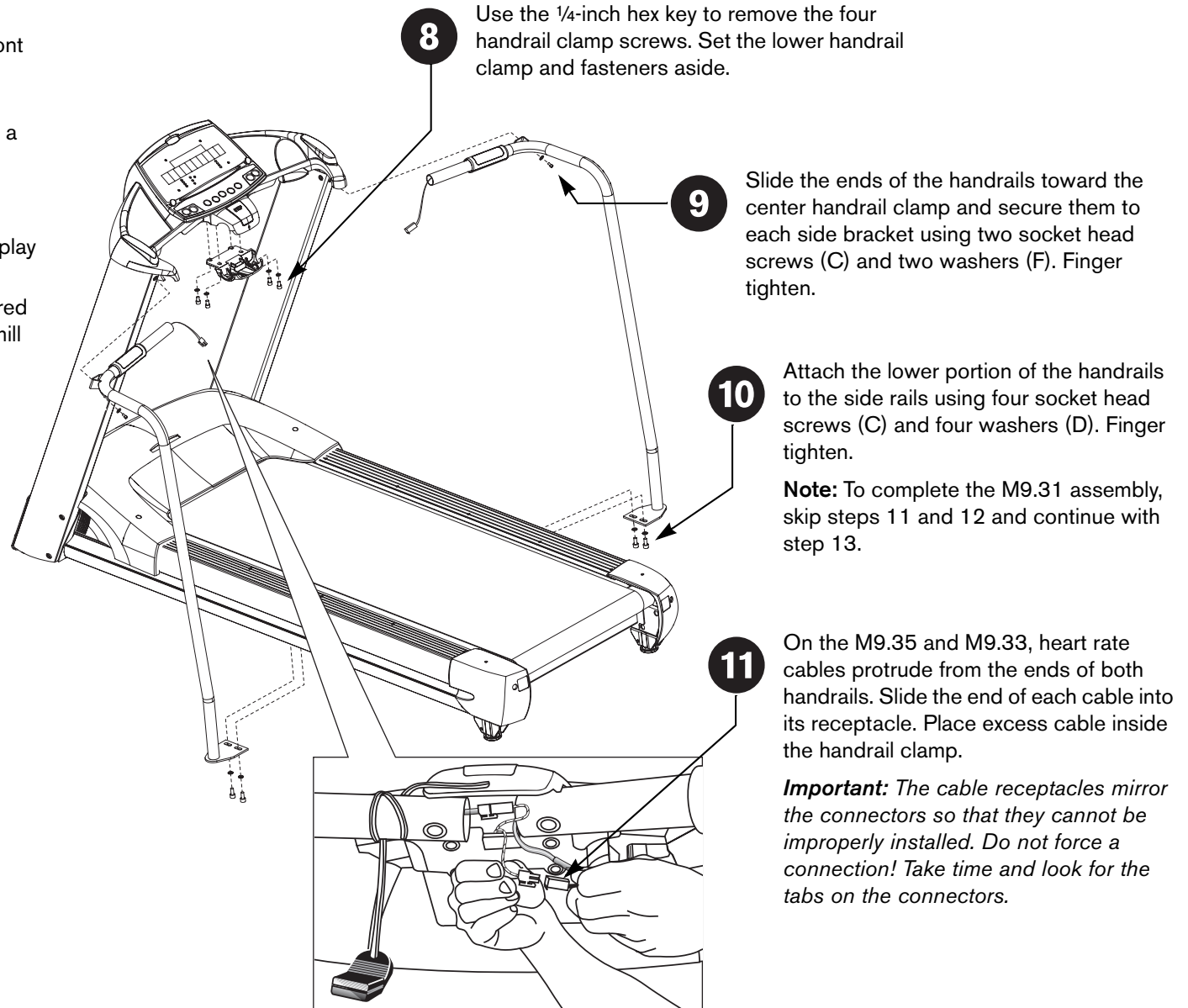

8

Use the 1/4-inch hex key to remove the four handrail clamp screws. Set the lower handrail clamp and fasteners aside.

9

Slide the ends of the handrails toward the center handrail clamp and secure them to each side bracket using two socket head screws (C) and two washers (F). Finger tighten.

10

Attach the lower portion of the handrails to the side rails using four socket head screws (C) and four washers (D). Finger tighten.

Note: To complete the M9.31 assembly, skip steps 11 and 12 and continue with step 13.

11

On the M9.35 and M9.33, heart rate cables protrude from the ends of both handrails. Slide the end of each cable into its receptacle. Place excess cable inside the handrail clamp.

Important: The cable receptacles mirror the connectors so that they cannot be improperly installed. Do not force a connection! Take time and look for the tabs on the connectors.

12

Test the heart rate feature on the M9.33 and M9.35.

- Turn the unit ON. The Precor banner appears in the display.
- Face the display and straddle the running belt.
- Place both hands on the touch-sensitive handrail grips. The letters **Hr** begin to blink in the Heart Rate display indicating that a signal is being transmitted. A heart rate appears within 15 seconds if you continue holding both grips.
- When the test is completed, turn the treadmill OFF and continue with step 13.

Note: If the blinking **Hr** does not appear, turn the unit OFF. Recheck the cable connections beneath the handrail clamp and ask someone else to test the heart rate feature.

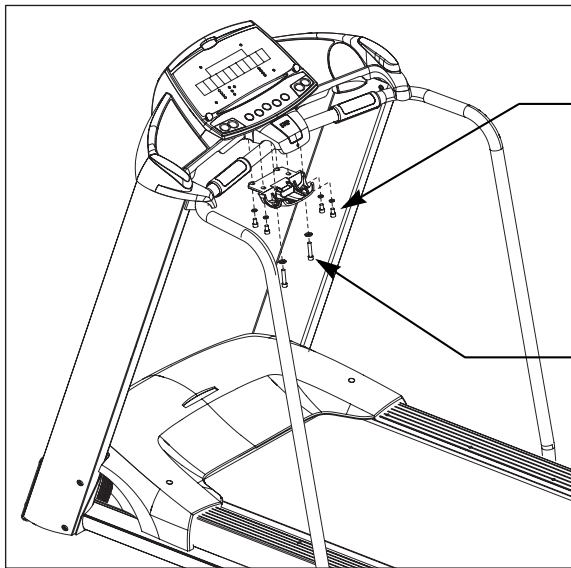
**13**

Replace the lower handrail clamp using the fasteners removed in step 8. Finger tighten.

14

Secure the handrails to the lower handrail clamp using two socket head screws (E) and two washers (F).

15

Tighten all mounting screws.

- Start at the front of the unit and alternately tighten the four front panel screws.
- Wrench tighten the four side upright screws.
- Wrench tighten the two handrail side screws.
- Wrench tighten the six handrail clamp screws.
- Wrench tighten the four side rail screws at the base of the handrails.

16

Lower the treadmill incline to zero using the INCLINE ▼ key. Turn the treadmill OFF.

17

Make sure the power cord is plugged into an appropriate outlet.

Important: The treadmill requires a dedicated, grounded circuit. A 20-amp circuit is recommended. Refer to Grounding Instructions in the owner's manual.

18

Check the alignment and adjust the running belt. For instructions, refer to *Checking the Alignment and Adjusting the Running Belt*.

Checking the Alignment and Adjusting the Running Belt

Proper belt alignment allows the belt to remain centered and ensures smooth operation. Realigning the belt takes a few simple adjustments. If you are unsure about this procedure, call Precor Customer Support at 1-800-347-4404.

To check the alignment:

1. The treadmill has adjustable rear feet. Make sure that the running surface is level. If the treadmill is placed on an uneven surface, adjusting the rear feet can help, but will not compensate for extremely uneven surfaces.

Important: Do not raise or lower the unit beyond 2 centimeters ($\frac{3}{4}$ inch). Check the level of the unit after each adjustment.

2. Turn the unit ON.
3. Stand beside the treadmill and press QUICKSTART.
4. If you are prompted for a password, press INCLINE ▼, SPEED ▼, SPEED ▲. The running belt starts automatically after the 3-second countdown appears on the display.
5. Press the SPEED s key until the display shows a speed of 3 mph (5 kph).
6. Walk around to the rear of the unit and observe the belt for a few minutes. The belt should run centered along the running bed. If the belt drifts off center, you will need to make adjustments.

Important: If the belt needs alignment, make the adjustments immediately after turning the treadmill OFF. Failure to do so may cause the belt to tear or fray, which is not covered by the Precor Limited Warranty.

7. To stop the running belt, press the red STOP button.
8. Turn the treadmill OFF.

To adjust the running belt:

CAUTION: To ensure your safety, turn OFF (O) the treadmill before making any adjustments.

1. Locate the right belt adjustment bolt in the rear end cap of the treadmill. (To determine left and right, stand at the rear of the treadmill and face the display.) Make all belt adjustments on the **right rear corner bolt** using the $\frac{1}{4}$ -inch hex key.

- If the belt is off center to the LEFT, turn the adjusting bolt $\frac{1}{4}$ turn counterclockwise, which moves the running belt to the right.
- If the belt tracks off center to the RIGHT, turn the bolt $\frac{1}{4}$ turn clockwise; this moves the belt to the left.

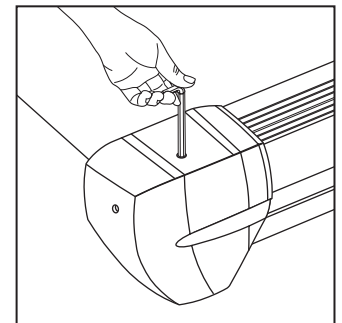

Important: Do not turn the adjusting bolt more than $\frac{1}{4}$ turn at a time. Overtightening the bolt can damage the treadmill.

2. Recheck the alignment of the running belt.



Precor Incorporated
20031 142nd Avenue NE
P.O. Box 7202
Woodinville, WA USA 98072-4002

©2005 Precor Incorporated
www.precor.com
M9.3x Online AG 48202-403
28 March 2005